

NOTE: It is recommended that two persons assemble this unit.

# ASSEMBLY INSTRUCTIONS

# PARTS LISTS

# 1

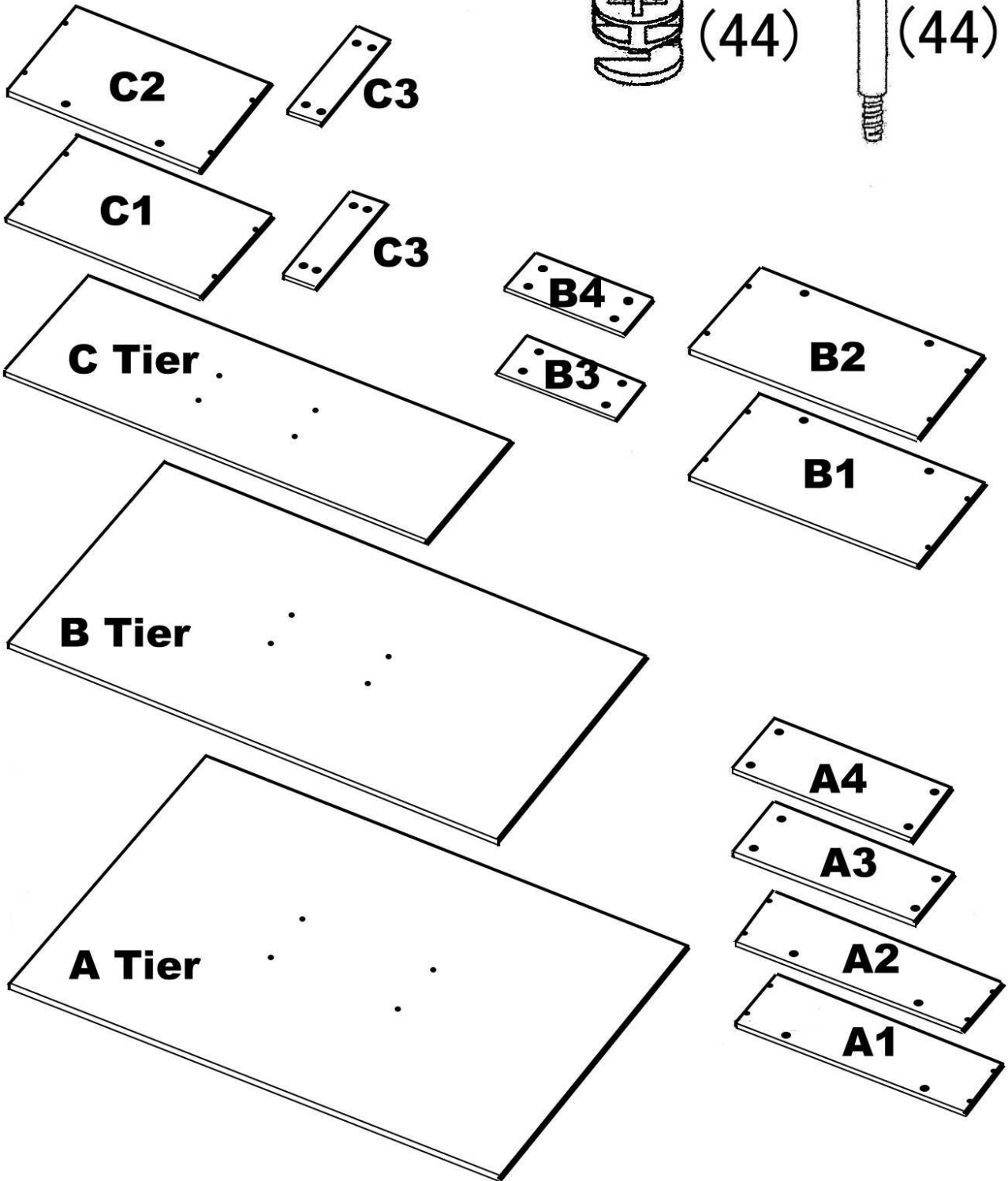

## TOOLS REQUIRED

*Hand Tighten Only!  
Do Not Overtighten!*

**2**



**(20)**

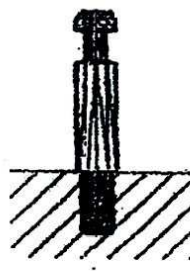
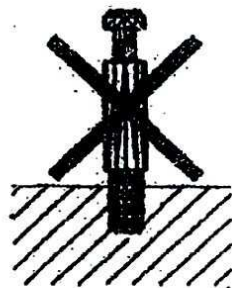
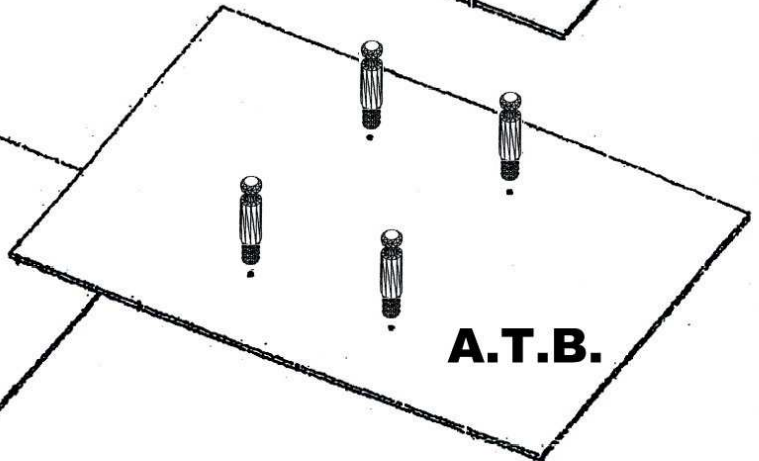
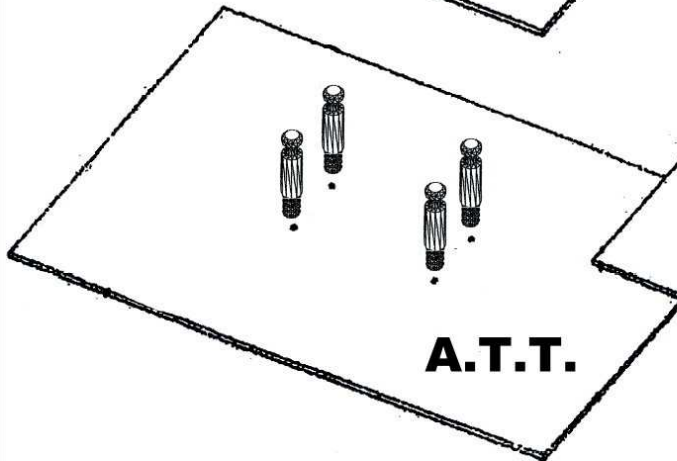
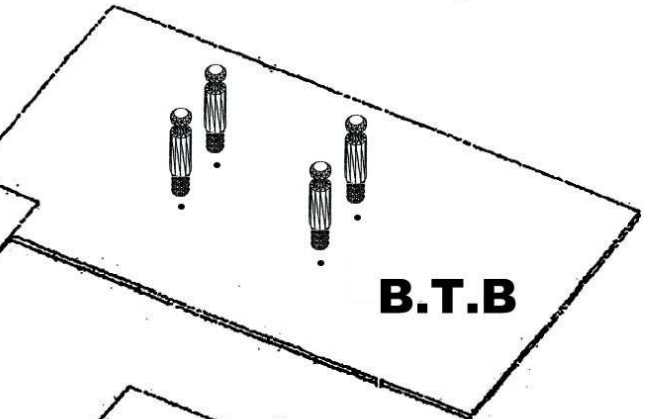
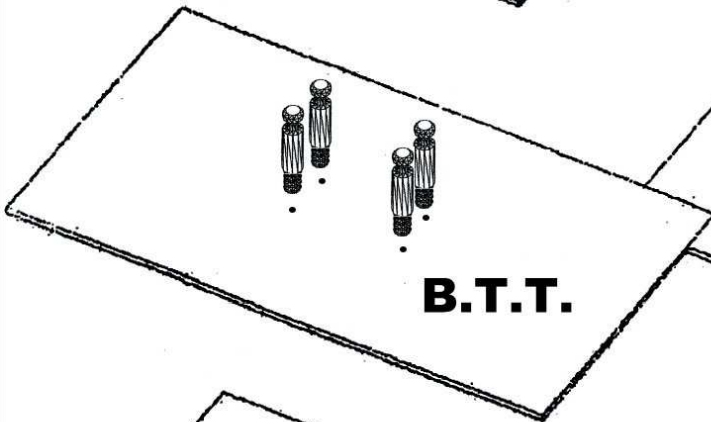
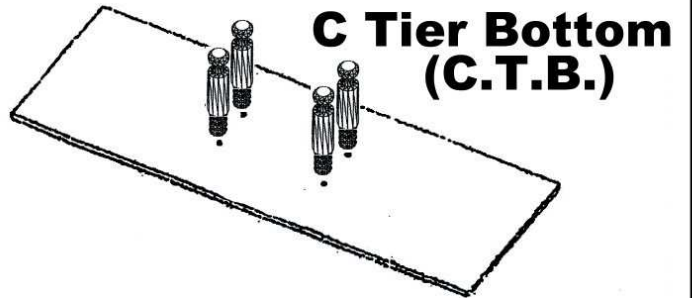
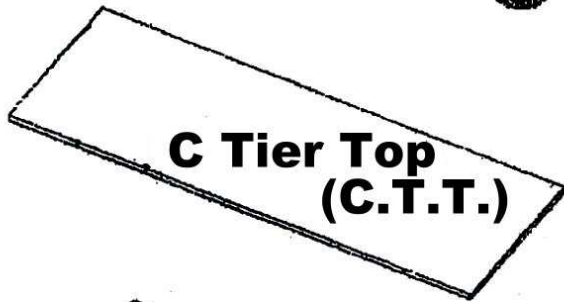

# 3

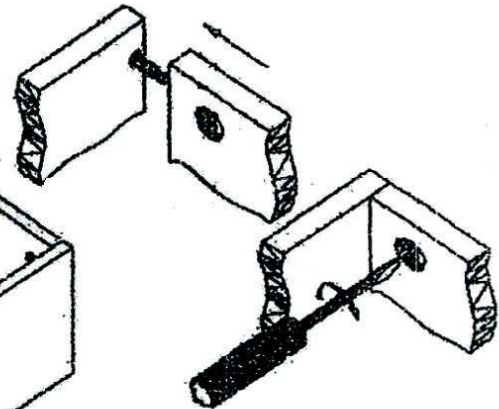
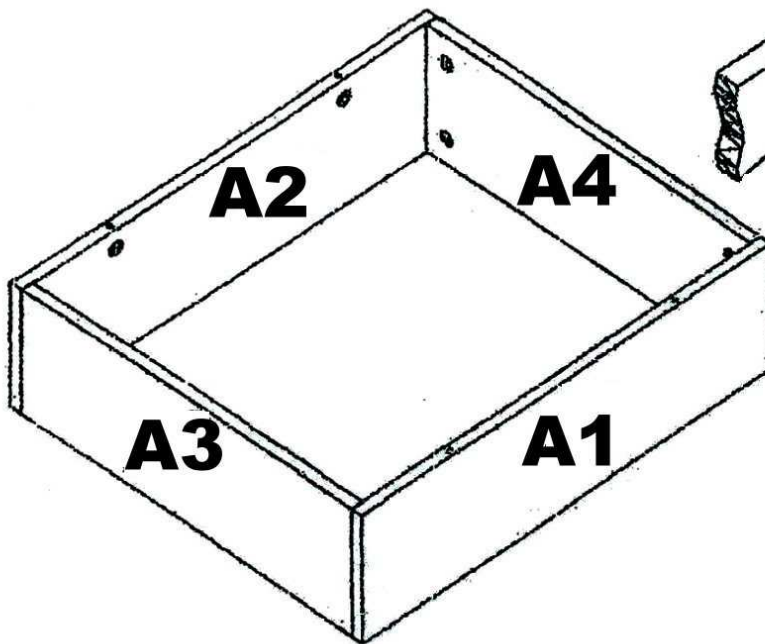
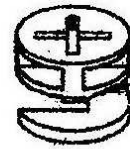
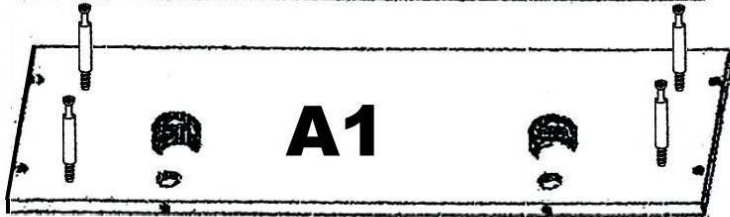
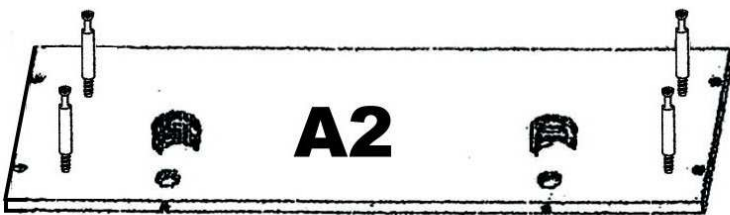
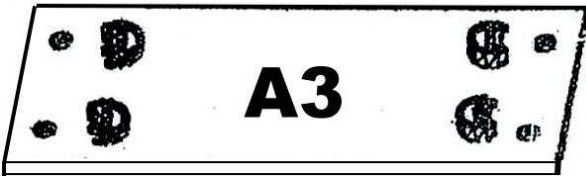
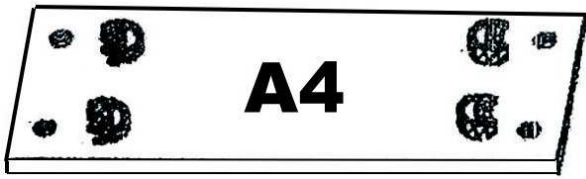

## BASE ASSEMBLY

4

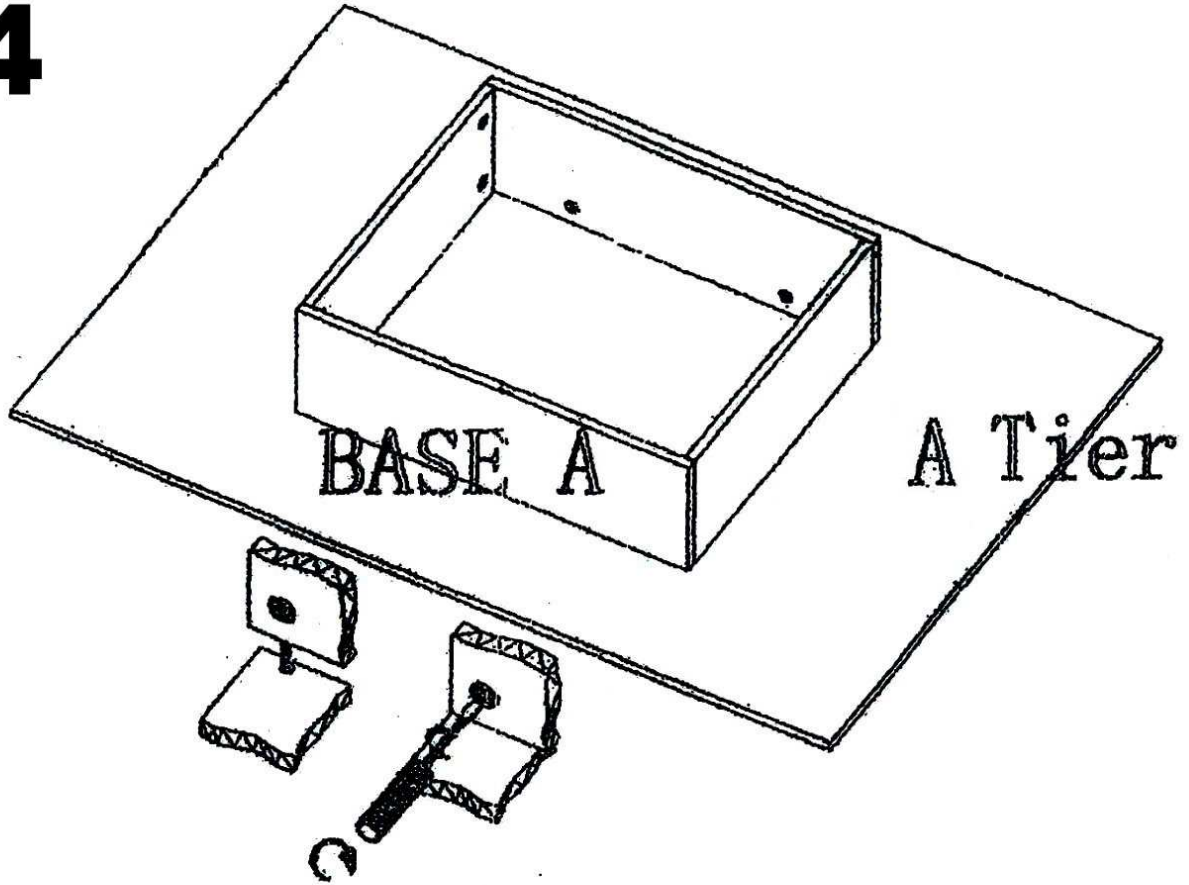

5

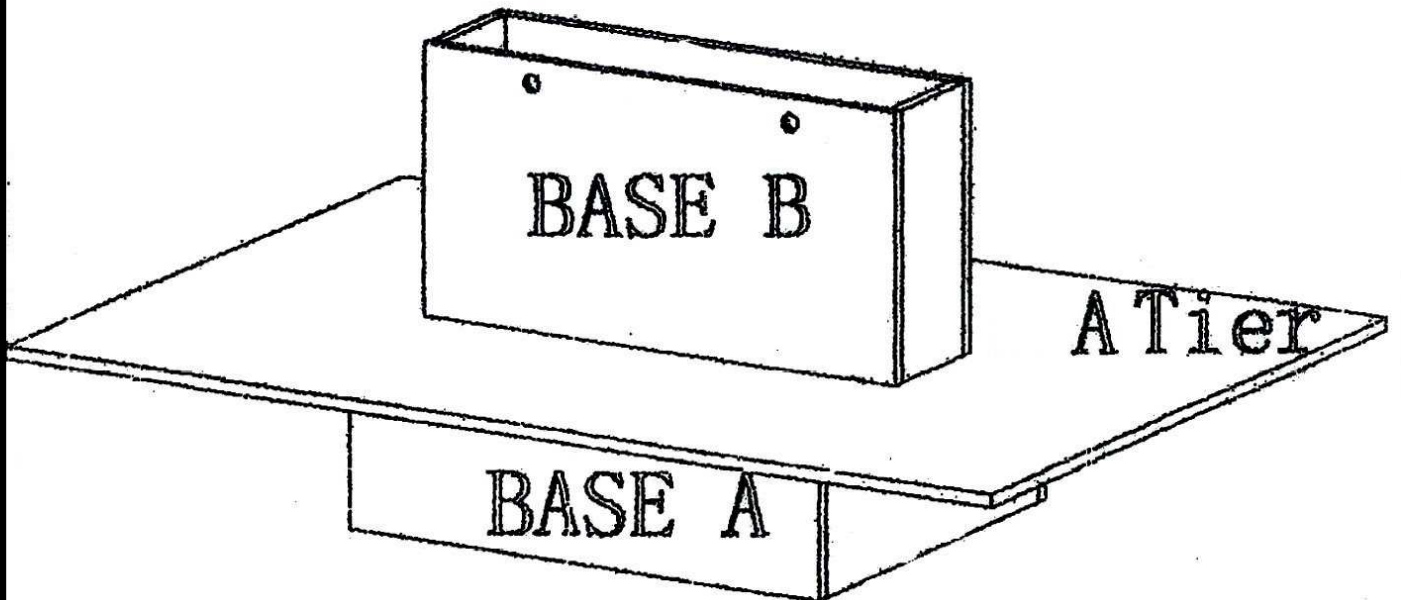

6

